

Electric Steam Tables

Standard Features

- Fully insulated open wells—all four sides and bottom of wells are insulated by fiberglass, 8" deep, dry heating style, open well design
- Temperature control—individual infinite switch controls each well
- Two type heat elements—500 watt per well and 750 watt per well
- Stainless steel die-stamped opening—12"x20" rising lip around well helps keep well clean and makes food pans easy to load and unload
- Poly cutting board—7" wide x 1/2" thick with 18 gauge stainless steel support shelf and brackets
- 18 gauge stainless steel top, body and under shelf
- Stainless steel tubular legs with adjustable stainless steel feet, giving tables a strong structure
- Indicator light of each well shows both power on and element heating
- Mechanical guards on all switches for safety and reliability
- Standard with water pans

Optional Accessories

- Casters (set of 4) item # CSTEAM-2-016
- Overshelf weight capacity: MROS-2ST: 50lbs, MROS-3ST: 70lbs, MROS-4ST: 80lbs, MROS-5ST: 85lbs

MODELS:

CSTEAM-2C/CSTEAM-3C/CSTEAM-4C/CSTEB-5C

CSTEAM-2C



CSTEB-5C

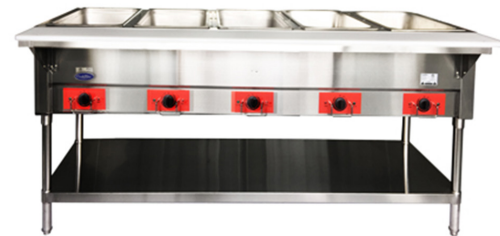

CSTEAM-3C



CSTEAM-4C

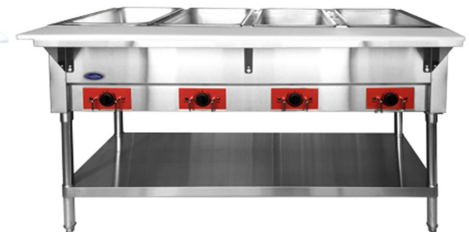

MROS-2ST



30^{1/5} × 12^{1/5} × 16^{1/10}

MROS-3ST



44^{3/10} × 12^{1/5} × 16^{1/10}

MROS-4ST



58^{2/5} × 12^{1/5} × 16^{1/10}

MROS-5ST



72^{1/2} × 12^{1/5} × 16^{1/10}



1 YEAR PARTS AND LABOR WARRANTY (US ONLY)



Conforms to ANSI
STD Z83.11-2009 (2011)
Certified for CSA
STD 1.4B-2009 (2011)
Conforms to NSF/ANSI STD.4



REV. 08/23

"WE MAKE THE KITCHEN BETTER!"

SPECIFICATIONS

Models	Voltage (V)	Wells	Watts/Well (W)	Total Watts	PH	Top Opening	Cu.ft.	Plug	Exterior Dimensions (inch)	Net Weight (lbs)	Gross Weight (lbs)
CSTEА-2C	120	2	500	1000	1	2	10.9	NEMA-5-15P	30×29 ^{1/2} ×33 ^{1/2}	64	77
CSTEА-3C	120	3	500	1500	1	3	15.5	NEMA-5-15P	44 ^{1/8} ×29 ^{1/2} ×33 ^{1/2}	84	104
CSTEА-4C	120	4	500	2000	1	4	19.8	NEMA-5-20P	58×29 ^{1/2} ×33 ^{1/2}	98	131
CSTЕB-5C	240	5	750	3750	1	5	29.7	NEMA-L6-20P	72 ^{1/2} ×29 ^{1/2} ×33 ^{1/2}	123	168

PLAN VIEW

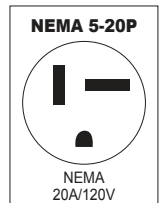
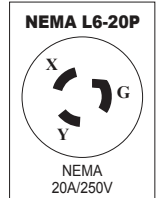
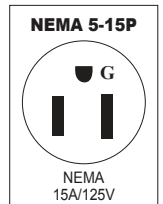
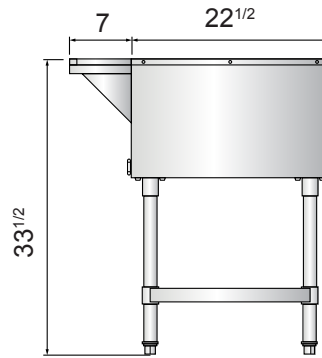
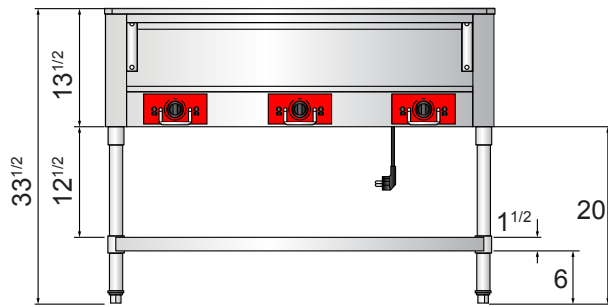
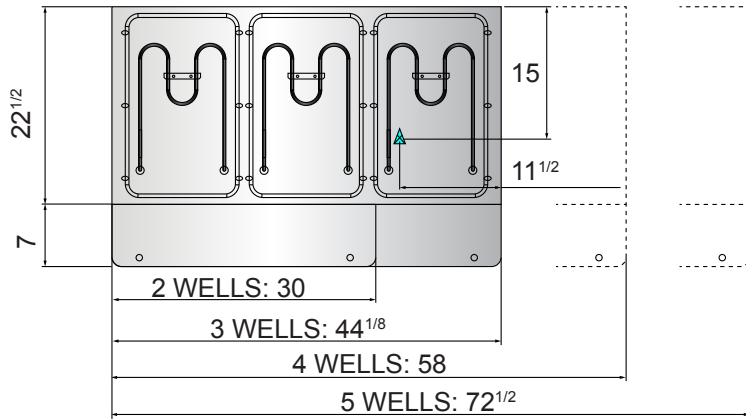

Fully insulated wells Stainless steel exterior Temperature control Stainless steel legs

